

# PK8(WZS),PK4(WZS)

## Zigbee 3.0 Wall Mounted Scene Panel

- 4/8 button scene panel remote with scene recall.
- Built-in Tuya Zigbee 3.0 remote module, supports scenario linkage and one-click execution.
- Set scene function through Tuya smart APP.
- Each button has a blue LED indicator.
- Customizable button words.
- Provide a variety of English button stickers, which can flexibly define the functions of each button.  
Button name: All ON, All OFF, Go home, Leave home, Main lighting, Comfort, Bright, Play, Film, Reception, Work, Read, Get up, Sleep, Living room, Dining room, Atmosphere, Spotlight, Light strip, Downlight, Curtain ON, Curtain OFF, All ON/OFF, ON/OFF.



PK8(WZS)



PK4(WZS)

CE RoHS emc RED

4, 8 Scene button / Zigbee 3.0 / AC input

### Technical Parameters

Input and Output		Safety and EMC		Environment	
Input voltage	100-240VAC	EMC standard (EMC)	ETSI EN 301 489-1 V2.2.3 ETSI EN 301 489-17 V3.2.4	Operation temperature	Ta: -30°C ~ +55°C
Input current	Max 0.1A	Safety standard	EN 61348-1:2015+A1:2021 EN 61348-2-13:2014+A1:2017	Case temperature (Max.)	Tc: +65°C
Output signal	Zigbee 3.0	Radio Equipment(RED)	ETSI EN 300 328 V2.2.2	IP rating	IP20
Remote distance	30m(Barrier-free space)	Certification	CE,EMC,RED	<b>Package</b>	
<b>Warranty</b>		Size			L112 x W112 x H50mm
Warranty	5 years	Gross weight			0.223kg

### Mechanical Structures and Installations

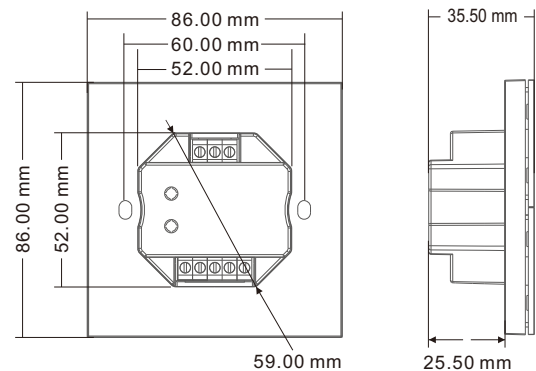
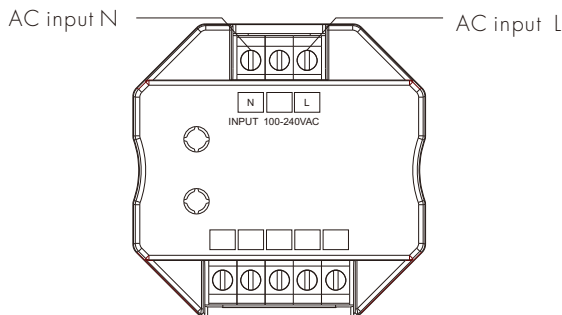

Installation diagram:

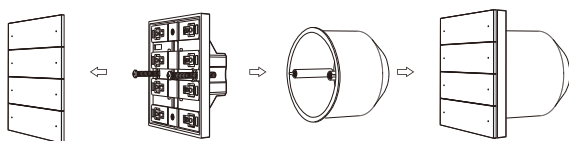

Uninstall button    Turn the screw    Base    Install the button

Typical base as below:

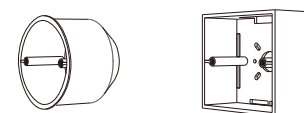

European style

86 size

### Key function

Short press the scene button to recall the corresponding scene, the blue light flashes 6 times.  
Press and hold the scene button for 3 seconds to close the corresponding scene(only for group control), the blue light flashes 6 times.

Before use the scene panel, please edit the scene setting through Tuya smart / Smart life APP firstly.

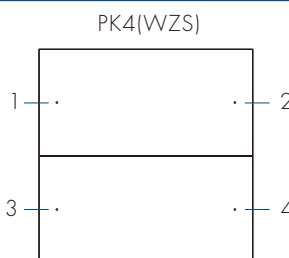

1: Scene 1    2: Scene 2  
3: Scene 3    4: Scene 4

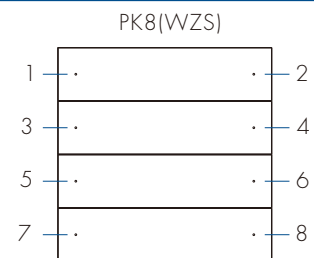

1: Scene 1    2: Scene 2    3: Scene 3    4: Scene 4  
5: Scene 5    6: Scene 6    7: Scene 7    8: Scene 8

## APP Operating Instructions

### 1. Network pairing

- Download the Tuya smart APP and register an account, search and add the Tuya Zigbee gateway device.
- For PK4(WZS): Press and hold the "Scene 1" and "Scene 4" button until the 4 LED indicator light flashes.  
Under the gateway, you can find WZS-Scene Panel device in Tuya smart APP.  
After successful network pairing, the 4 LED indicator light will be on for 2 seconds and then off.
- For PK8(WZS): Press and hold the "Scene 1" and "Scene 8" button until the 8 LED indicator light flashes.  
Under the gateway, you can find WZS-Scene Panel device in Tuya smart APP.  
After successful network pairing, the 8 LED indicator light will be on for 2 seconds and then off.
- Under the gateway, search and add one or more ZBS-DIM, ZBS-CCT, ZBS-RGB, ZBS-RGBVW, ZBS-RGB+CCT light devices.
- Unpair scene panel: Re-operate the pairing action to unpair.

### 2. Remote association and scene settings

There are 8 scenes in the Tuya smart APP, which can be set to group control or linkage scenes.  
group control is used for the overall control of multiple lamps, like the light adjustment of the entire room.  
Linkage scene is used for linkage control of different equipment, such lamps and curtains on and off together.

Example 1, set scene 1 for synchronous light control of the whole room:

- (1) Select scene 1 and open the group control settings.
- (2) You can change the scene name, add one or more devices, adjust brightness and color, then save it.
- (3) After successful setting, you can use the remote to control these lamps directly.

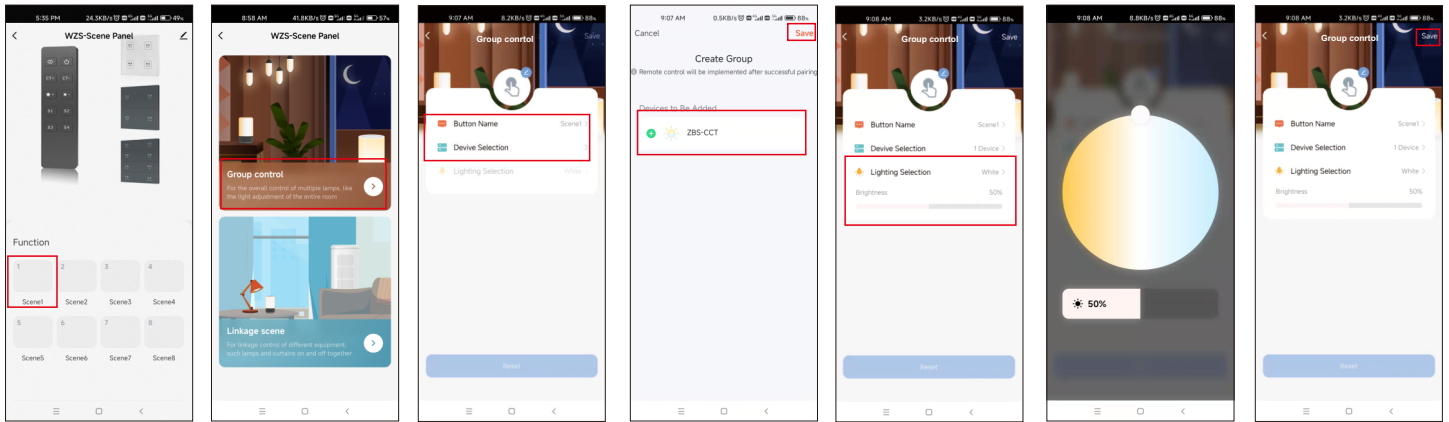

Example 2, set scene 2 to set up a scenario where different lamps or curtains are controlled together with different color or on/off state.

- (1) Select Scene 2 and open the linkage scene settings.
- (2) You can change the scene name, add "one-click execution" tasks, select the devices that need to be linked, save the required functions, such as ON/OFF, mode, brightness and color temperature.
- (3) After successful setup, you can use the remote to directly control all linked devices to the desired scene.

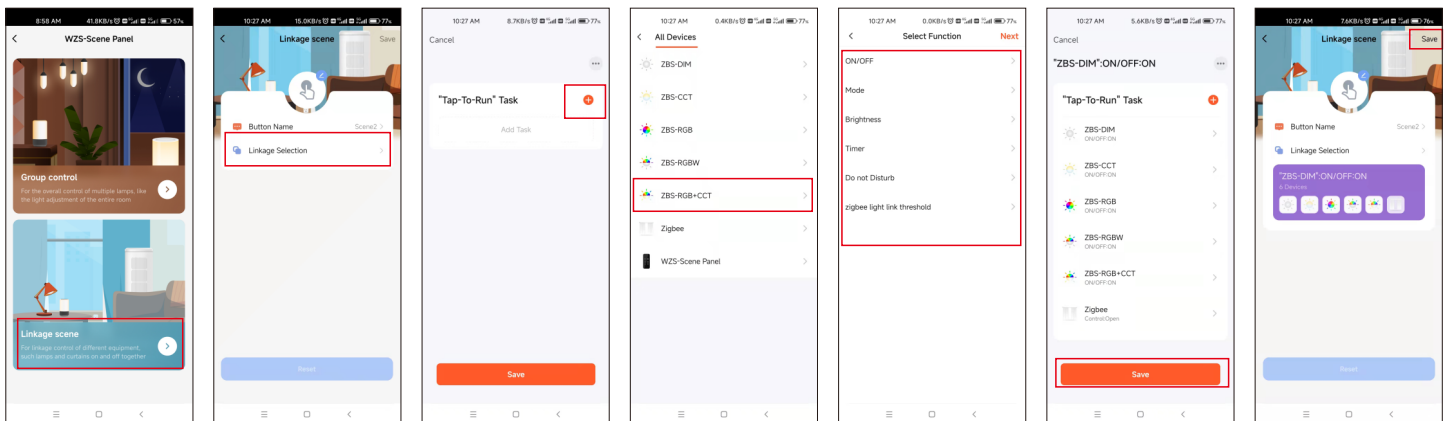

Note:

- The scene 1-8 in Tuya smart APP is correspond to the scene 1-8 button on the scene panel.
- You can select one scene button to set ALL OFF linkage scene function to turn off all lights.
- To delete the scene function, you can select "Reset" in the scene settings.

## Installation Precautions

1. The installation height is  $\geq 1M$  from the ground to avoid the shortening of the remote control distance due to weak transmitting/receiving signals.
2. The products are not allowed to be close to or covered by metal objects, with an interval of  $\geq 20cm$  to avoid signal attenuation and shorten the remote distance.

## Packing List

