

Intelligent Tunable White LED Driver (Constant Current)

- Housing made from SAMSUNG/COVESTRO's V0 flame retardant PC materials.
- Ultra small, thin and lightweight, screwless end cap.
- Change the output current, dimming mode and other parameters via the APP.
- Adjustable output current with 1mA step.
- Automatically recognize 0-10V and 1-10V input signal.
- Ultra-low consumption of 0-10V ports < 0.05mA.
- Soft-on and fade-in dimming function enhances your visual comfort.
- T-PWM™ super deep dimming technology, 0.01% dimming depth.
- The whole dimming process is flicker-free with high frequency exemption level.
- Comply with the EU's ErP Directive, networked standby<0.5W.
- When there is no load, the output will be 0V to prevent damage to LEDs due to poor contact.
- Overheat, over voltage, overload, short circuit protection and automatic recovery.
- Suitable for Class I / II / III indoor light fixtures.
- Normal service life can reach 100,000 hours.
- 5-year warranty (Rubycon capacitor).

4 in 1 dimming
0-10V
1-10V
10V PWM
RX



T-PWM™
Dimming Technology

Flicker Free
IEEE 1789

Dimmable:
10000 : 1



The certification icon represents undergoing certification applications only, and final certification qualification subject to actual product.



Technical Specs

Model		SE-20-100-700-W2A		
Features	Output Type	Constant current		
	Dimming Interface	0-10V [1-10V, 10V PWM, RX]		
	Output Feature	Isolation		
	Protection Grade	IP20		
OUTPUT	Insulation Grade	Class II [Suitable for class I/II/III light fixtures]		
	Output Voltage	9-42Vdc		
	Maximum output voltage	≤48Vdc		
	Output Current Range	100-700mA		
	Output Power Range	0.9W-20W		
	Dimming Range	0-100%, down to 0.01%		
	LF Current Ripple	<3% [Maximum current for non dimming state]		
	Current Accuracy	±5%		
INPUT	PWM Frequency	≤3600Hz		
	DC Voltage Range	120-300Vdc		
	AC Voltage Range	100-240Vac		
	Input Voltage	115Vac/230Vac		
	Frequency	50/60Hz		
	Input Current	≤0.25A/115Vac, ≤0.13A/230Vac		
	Power Factor	PF>0.95/115Vac [at full load], PF>0.9C/230Vac [at full load]		
	THD	THD≤10%/230Vac, at full load		
	Efficiency (Typ.)	84%@700mA [at full load], 87%@500mA [at full load],		
	Inrush Current	Cold start 15A[Test twidth=102us tested under 50% Ipeak]/230Vac		
ENVIRONMENT	Anti Surge	L-N: 2KV		
	Leakage Current	Max. 0.24mA		
	Working Temperature	ta: -20 ~ 45°C tc: 80°C		
	Working Humidity	20 ~ 95%RH, non-condensing		
	Storage Temperature/Humidity	-40 ~ 80°C/10-95%RH		
PROTECTION	Temperature Coefficient	±0.03%/°C [0-50°C]		
	Vibration	10-500Hz, 2G 12min/1cycle, 72 min for X, Y and Z axes respectively		
	Overload Protection	Automatically protect the device when the load exceeds 102% of the rated power. Automatically recover once load is reduced		
	Overheat Protection	Intelligently adjust or turn off the current output if the PCB temperature ≥110°C. When the PCB temperature <90°C, automatically recover normal output		
SAFETY & EMC	Overvoltage Protection	Automatically protect the device when voltage exceeds the no-load voltage. It can be recovered automatically		
	Short Circuit Protection	Enter hiccup mode if short circuit occurs, and recover automatically		
	Withstand Voltage	I/P-O/P: 3750Vac		
	Insulation Resistance	I/P-O/P: 100MΩ/500VDC/25°C/70%RH		
	Safety Standards	CCC	China	GB19510.1, GB19510.14
		TUV	Germany	EN61347-1, EN61347-2-13, EN62493
		CB	CB Member States	IEC61347-1, IEC61347-2-13
		CE	European Union	EN61347-1, EN61347-2-13, EN62384
		KC	Korea	KC61347-1, KC61347-2-13
		EAC	Russia	IEC61347-1, IEC61347-2-13
		RCM	Australia	AS 61347-1, AS 61347-2-13
		ENEC	Europe	EN61347-1, EN61347-2-13, EN62384
UKCA		Britain	BS EN 61347-1, BS EN 61347-2-13, BS EN 62493	
BIS		India	IS 15885 (PART 2/SEC 13)	
EMC Emission	CUL	Canada	CSA C22.2 NO.250.13	
	UL	America	UL 8750	
	CCC	China	GB/T17743, GB17625.1	
	CE	European Union	EN55015, EN61000-3-2, EN61000-3-3, EN61547	
	KC	Korea	KSC 9815, KSC 9547	
	EAC	Russia	IEC62493, IEC61547, EH55015	
	RCM	Australia	EN55015, EN61000-3-2, EN61000-3-3, EN61547	
	UKCA	Britain	BS EN IEC 55015, BS EN IEC 61000-3-2, BS EN 61000-3-3, BS EN 61547	
EMC Immunity	CUL	Canada	ICES-005	
	UL	America	FCC PART 15B	
ErP	Power Consumption	Networked standby	<0.5W (After shutdown by command)	
		No-load power consumption	<0.5W (When the lamp is not connected)	
	Flicker/Stroboscopic Effect	IEEE 1789	Meet IEEE 1789 standard/High frequency exemption level	
		CIE SVM	Pst LM≤1.0, SVM≤0.4	
OTHERS	DF	Phase factor	DF≥0.9	
	Weight(N.W.)	105g±10g		
	Dimensions	127×40×23mm(L×W×H)		

Product Size

Unit: mm

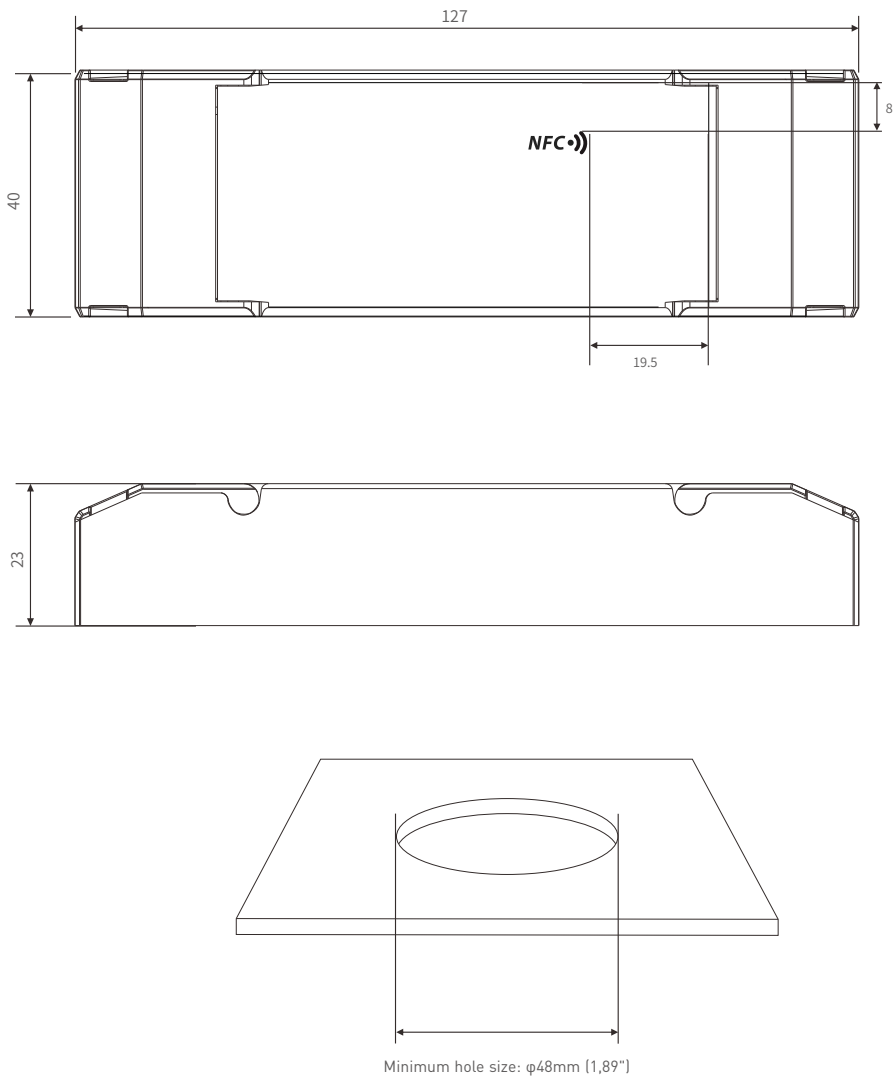

Wiring Diagram

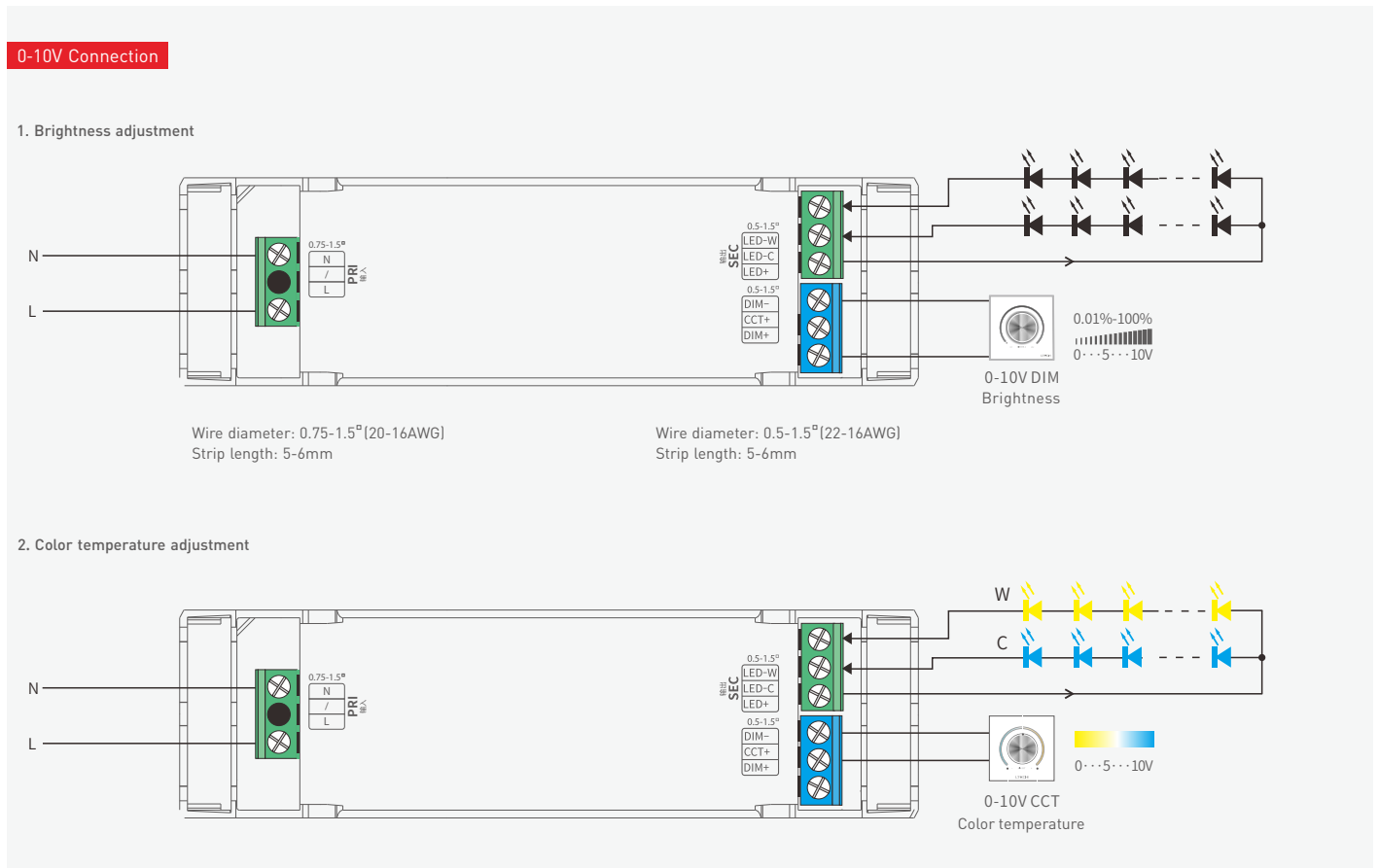

3. Brightness and color temperature adjustment respective

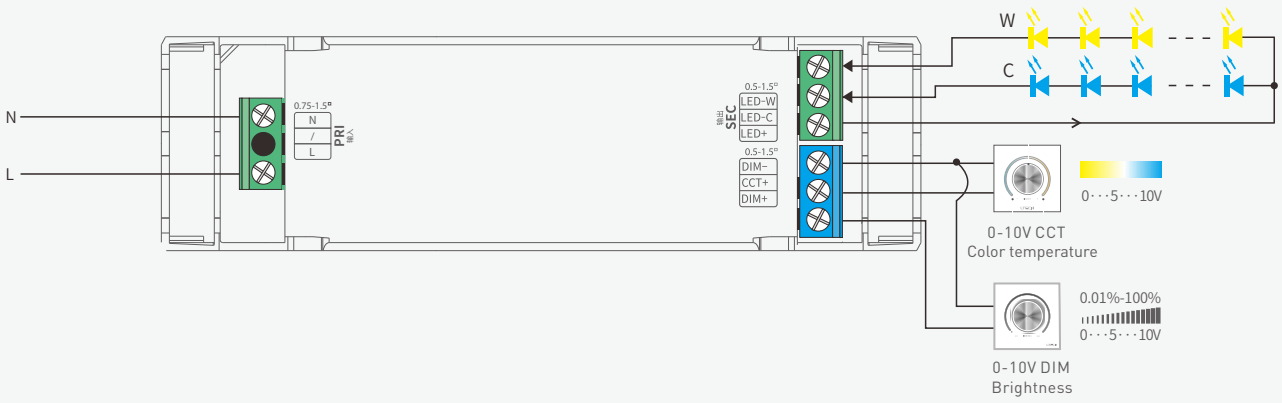

4. Brightness and color temperature adjustment simultaneous

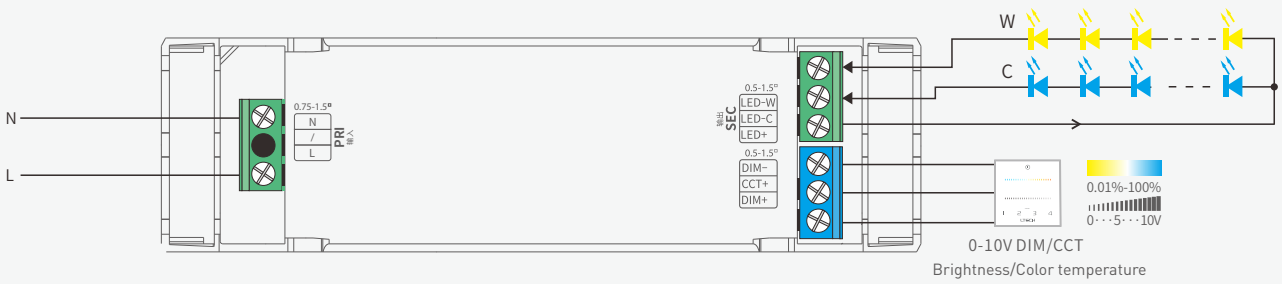

Four-wire LED connection

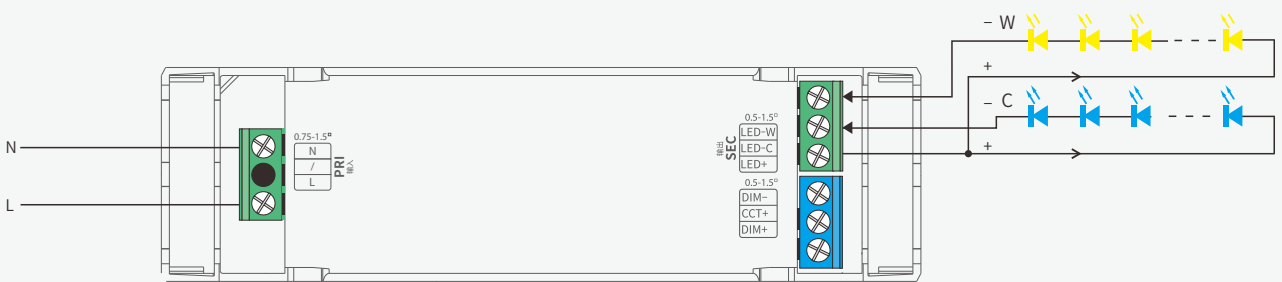

* Adopting constant power program design, it keeps the same brightness in color temperature dimming, twice the rated power load can be connected.
20W driver, 20W X 2CH load can be connected, the total power of the 2 channels will be kept in 20W.

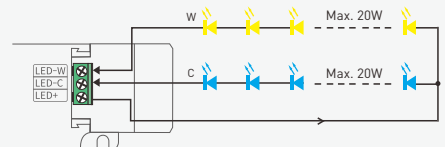

Table of Typical Corresponding Parameters for Current

The typical 13 current data sets below are for reference when selecting LED fixture models. More current levels can be set by NFC using mobile APP with 100-700mA adjustable in 1mA step

Output Current	100mA	150mA	200mA	250mA	300mA	350mA	400mA
Output Voltage	9-42Vdc	9-42Vdc	9-42Vdc	9-42Vdc	9-42Vdc	9-42Vdc	9-42Vdc
Output Power	0.9-4.2W	1.35-6.3W	1.8-8.4W	2.25-10.5W	2.7-12.6W	3.15-14.7W	3.6-16.8W
Output Current	450mA	500mA	550mA	600mA	650mA	700mA	/
Output Voltage	9-42Vdc	9-40Vdc	9-37Vdc	9-34Vdc	9-31Vdc	9-28.5Vdc	/
Output Power	4.05-18.9W	4.5-20W	4.95-20.35W	5.4-20.4W	5.85-20.15W	6.3-19.95W	/

Application Diagram of Protective Cover



1. Put the head of a screwdriver on the side of the housing to pry up both the protective cover and wire fixing board. Then remove the wire fixing board and connect to the wires as wiring diagram shows.

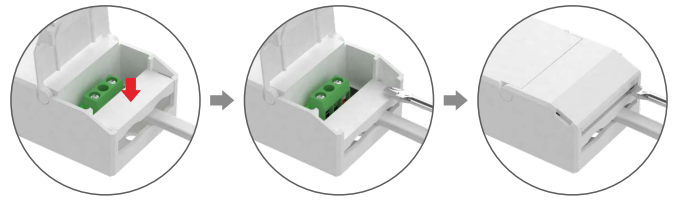

2. Install the wire fixing board and press it down. Then snap on the protective cover while pressing the wire fixing board with a small flat-head screwdriver

Installation Precautions

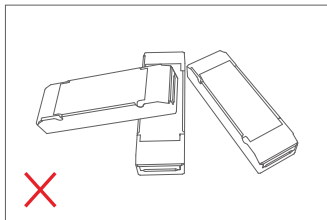

Please do not stack the products. The distance between two products should be $\geq 15\text{cm}$ so as not to affect heat dissipation and the lifespan of the products.

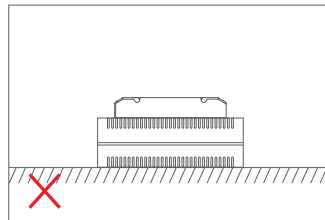
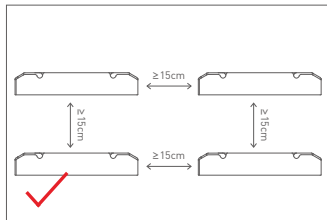

Please not place the products on LED drivers. The distance between the product and the driver should be $\geq 15\text{cm}$ so as not to affect heat dissipation and shorten the lifespan of the products.

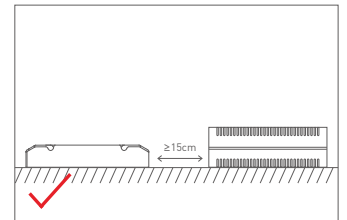

Note: The temperature within the installation area should be within the working temperature range of the products. Please do not install products inside LED fixtures to avoid temperature exceeding the working temperature that may affect the product lifetime.

Use the NFC Lighting APP

Scan the QR code below with your mobile phone and follow the prompts to complete the APP installation (According to performance requirements, you need to use a NFC-capable Android phone, or an iPhone 8 and later that are compatible with iOS 13 or higher).



* Before you begin setting the parameters of the driver, please make sure the driver is powered off.

Read/Write the LED driver

Use your NFC-capable phone to read LED driver data, then edit the parameters and they can be directly written to the driver.

1. Read the LED driver

On the APP home page, click **[Read/Write LED driver]**, then keep the programmer's sensing area close to the NFC logo of the driver to read the driver parameters.



2. Edit the parameters

Click **[Parameter settings]** to edit the advanced parameters, like output current, dimming mode, low power mode, etc.

3. Write to the driver

After completing the parameter settings, click **[Write]** in the upper right corner, and keep the programmer's sensing area close to the NFC logo of the driver, so the parameters can be written to the driver.

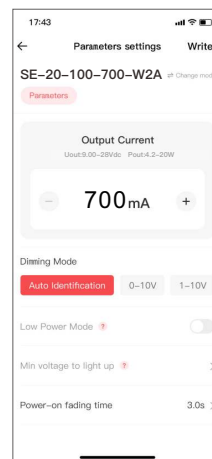
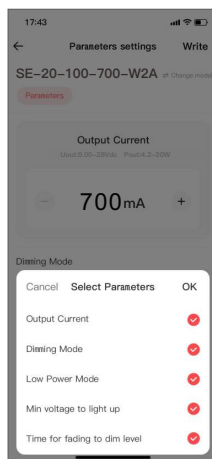
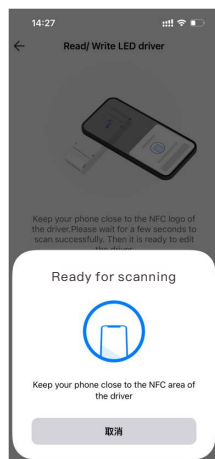

Relationship Diagrams

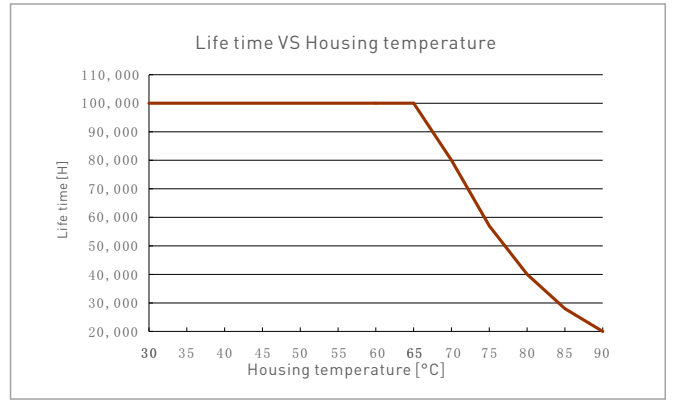
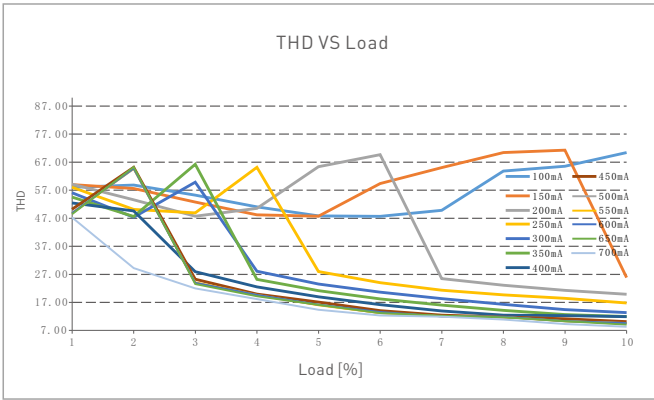
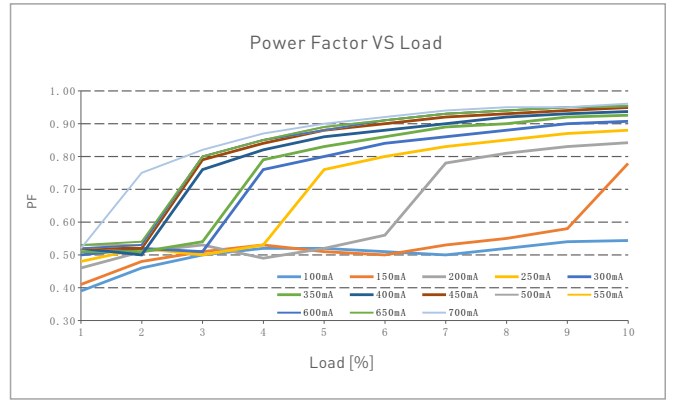
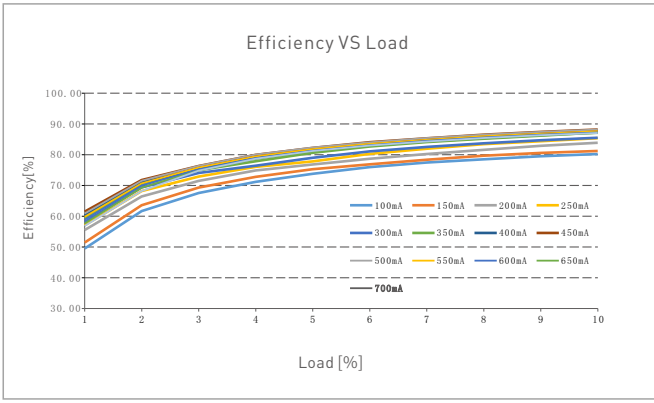

SE-20-100-700-W2A

Flicker Test Sheet

IEEE 1789

Limit of modulation in low risk area	
Waveform frequency of optical output	limit (%)
$f \leq 8\text{Hz}$	0.2
$8\text{Hz} < f \leq 90\text{Hz}$	$0.025 \times f$
$90\text{Hz} < f \leq 1250\text{Hz}$	$0.08 \times f$
$f > 1250\text{Hz}$	Exemption assessment
Limit of modulation in no effect area	
Waveform frequency of optical output	limit (%)
$f \leq 10\text{Hz}$	0.1
$10\text{Hz} < f \leq 90\text{Hz}$	$0.01 \times f$
$90\text{Hz} < f \leq 3125\text{Hz}$	$[0.08/2.5] \times f$
$f > 3125\text{Hz}$	Exemption assessment (High frequency exemption)

Brightness

- ▲ 0.1%
- ▲ 1%
- ▲ 5%
- ▲ 10%
- 20%
- 30%
- 40%
- ★ 50%
- ★ 60%
- ★ 70%
- ★ 80%
- ★ 90%
- ◆ 100%

- Modulation Area Diagram
- ▨ High Frequency Exemption Area Diagram

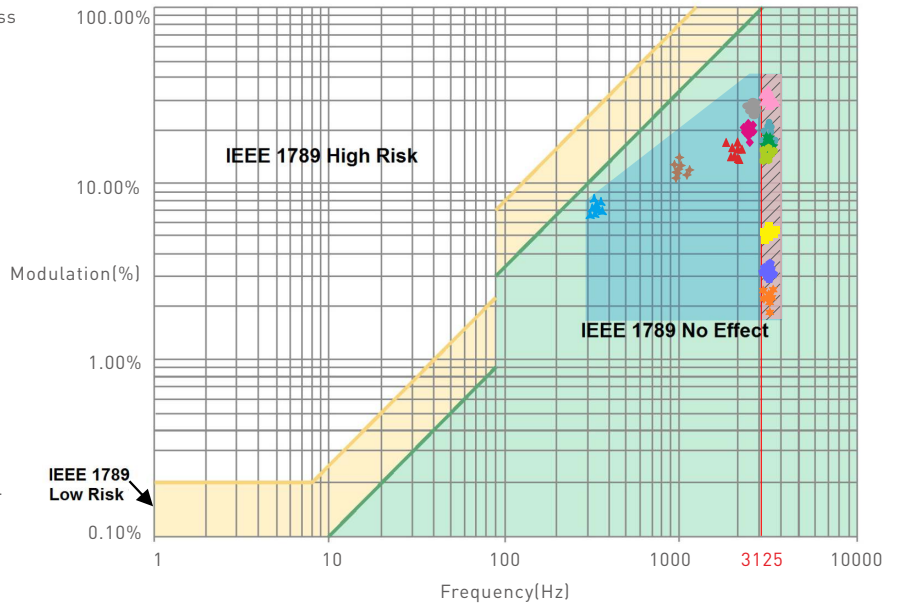

Marks in the right chart were tested results of different current ranges. The output frequency is 0Hz in 100% brightness and its corresponding modulation is 0%, which could not be shown in the right chart.

Packaging Specifications

Model	SE-20-100-700-W2A
Carton Dimensions	290×275×106mm(L×W×H)
Quantity	20 PCS/Layer; 2 Layers/Carton; 40 PCS/Carton
Weight	0.11 kg/PC; 5.2 kg±5%/Carton

Packaging Image



Inner Packaging Box



Carton Packaging

Transportation and Storage

1. Transportation

Products can be shipped via vehicles, boats and planes.

During transportation, products should be protected from rain and sun. Please avoid severe shock and vibration during the loading and unloading process.

2. Storage

The storage conditions should comply with the Class I Environmental Standards. The products that have been stored for more than six months are recommended to be re-inspected and can be used only after they have been qualified.

Attentions

- This product must be installed and adjusted by a qualified professional.
- This product is non-waterproof (special models excepted). Please avoid the sun and rain. When installed outdoors, please ensure it is mounted in a water proof enclosure.
- Good heat dissipation will extend the life the product. Please install the product in a environment with good ventilation.
- When you install this product, please avoid being near a large area of metal objects or stacking them to prevent signal interference.
- Please keep the product away from a intense magnetic field, a high pressure area or a place where lightning is easy to occur.
- Please check whether the working voltage used complies with the parameter requirements of the product.
- Before you power on the product, please make sure all the wiring is correct in case of incorrect connection that may cause a short circuit and damage the components, or trigger a accident.
- If a fault occurs, please do not attempt to fix the product by yourself. If you have any question, please contact the supplier.

* This manual is subject to changes without further notice. Product functions depend on the goods. Please feel free to contact our official distributors if you have any question.

Warranty Agreement

- Warranty periods from the date of delivery: 5 years.
- Free repair or replacement services for quality problems are provided within warranty periods.

Warranty exclusions below:

- Beyond warranty periods.
- Any artificial damage caused by high voltage, overload, or improper operations.
- Products with severe physical damage.
- Damage caused by natural disasters and force majeure.
- Warranty labels and barcodes have been damaged.
- No any contract signed by LTECH.

1. Repair or replacement provided is the only remedy for customers. LTECH is not liable for any incidental or consequential damage unless it is within the law.
2. LTECH has the right to amend or adjust the terms of this warranty, and release in written form shall prevail.

Update Log

Version	Updated Time	Update Content	Updated by
A0	2023.05.23	Original version	Yang Weiling