

Intelligent Tunable White LED Driver (Constant Current)

- Small size and light weight. The housing is made from V0 flame retardant PC materials that SAMSUNG/COVESTRO uses.
- The clamshell design and screwless type for strain-relief. The design of dismountable end cap allows you to adjust the length of housing depending on your needs.
- Use Zigbee protocol and Tuya application protocol with high networking capability.
- With soft-on and fade-in dimming function, enhancing your visual comfort.
- Dimming from 0~100%, down to 0.1%.
- Color temperature range: 2700~6500K.
- Comply with the EU's ErP Directive, standby power consumption < 0.5W.
- The secure and reliable design for signal isolation.
- Innovative thermal management technology intelligently protects the life of the LED driver.
- Overheat, over voltage, overload, short circuit protection and automatic recovery.
- Up to 50,000-hour life time.
- 5-year warranty (Rubycon capacitor).



Flicker-free
IEEE 1789

Dimmable:
.....
0.1%~100%



Technical Specs

Model		LM-150-24-G2Z2		
Features	Output Type	Constant Voltage		
	Dimming Interface	Zigbee		
	Output Feature	Isolation		
	Protection Grade	IP20		
	Insulation Grade	Class II (Suitable for class I / II / III light fixtures)		
OUTPUT	Output Voltage	24Vdc		
	Output Voltage Range	24Vdc ± 0.5Vdc		
	Output Current	Max. 6.25A		
	Output Power	Max. 150W		
	Output Power Range	0~150W		
	Strobe Level	High frequency exemption level		
	Dimming Range	0~100%, down to 0.1%		
	Overload Power Limitation	≥102%		
	Ripple	Switch ripple≤200mV, noise≤500mV		
INPUT	PWM Frequency	≤3600Hz		
	DC Voltage Range	200~280Vdc		
	AC Voltage Range	220~240Vac		
	Rated Voltage	230Vac		
	Frequency	50/60Hz		
	Input Current	≤0.75A/230Vac		
	Power Factor	PF>0.98/230Vac (at full load)		
	THD	THD<6%@230Vac (at full load)		
	Efficiency (typ.)	93%		
	Standby power consumption	<0.5W		
	Inrush Current	Cold start 45A@230Vac (Test twidth=840us tested under 50% Ipeak)		
	Anti Surge	L-N: 2KV		
	Leakage Current	Max. 0.5mA		
ENVIRONMENT	Working Temperature	ta: -20 ~ 50°C tc: 85°C		
	Working Humidity	20 ~ 95%RH, non-condensing		
	Storage Temperature/Humidity	-40 ~ 80°C, 10~95%RH		
	Temperature Coefficient	±0.03%/°C (0~50°C)		
	Vibration	10~500Hz, 2G 12min/1cycle, 72 min for X, Y and Z axes respectively		
PROTECTION	Overheat Protection	Intelligently adjust or turn off the output current if the PCB temperature ≥110°C, and recover automatically		
	Overload Protection	Shut down the output when current load≥102%, and recover automatically		
	Short Circuit Protection	Enter hiccup mode if short circuit occurs, and recover automatically		
	Overvoltage Protection	Shut down the output when non-load voltage≥28V, and recover automatically		
SAFETY & EMC	Withstand Voltage	I/P-O/P: 3750Vac		
	Isolation Resistance	I/P-O/P: 100MΩ/500VDC/25°C/70%RH		
	Safety Standards	CCC	China	GB19510.1, GB19510.14
		TUV	Germany	EN61347-1, EN61347-2-13, EN62493
		CB	CB member states	IEC61347-1, IEC61347-2-13
		CE	European Union	EN61347-1, EN61347-2-13, EN62384, EN61547
		KC	Korea	KC61347-1, KC61347-2-13
		EAC	Russia	IEC61347-1, IEC61347-2-13
		RCM	Australia	AS61347-1, AS61347-2-13
	EMC Emission	EMEC	Europe	EN61347-1, EN61347-2-13, EN62384
		CCC	China	GB/T17743, GB17625.1
		CE	European Union	EN55015, EN61000-3-2, EN61000-3-3, EN61547
		KC	Korea	KN15, KN61547
		EAC	Russia	IEC62493, IEC61547, EH55015
		RCM	Australia	EN55015, EN61000-3-2, EN61000-3-3, EN61547
EMC Immunity		EN61000-4-2,3,4,5,6,8,11, EN61547		
Strobe Test Standard	IEEE 1789			
OTHERS	Life Time	50000 hours		
	Warranty	5 years		

Product Size

Unit: mm

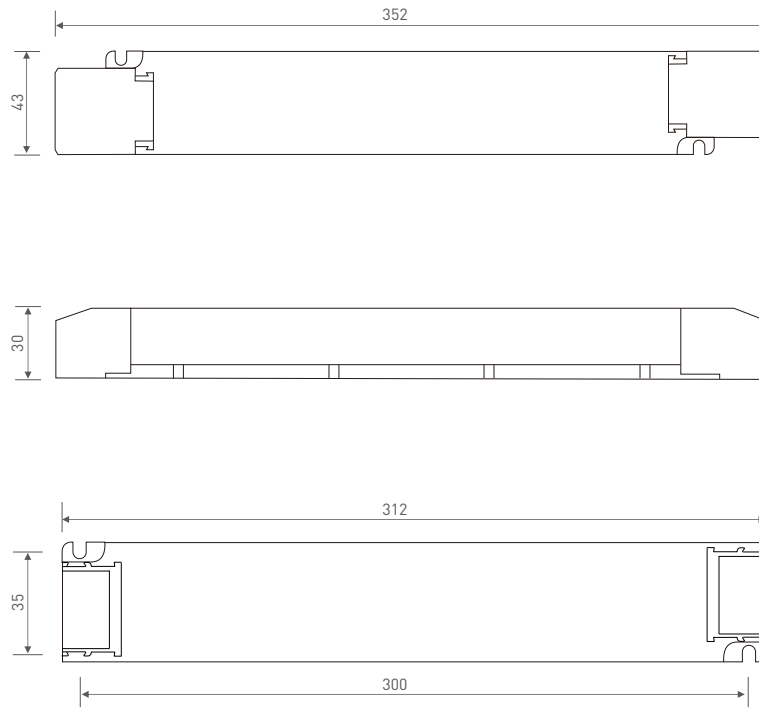

Wiring Diagram

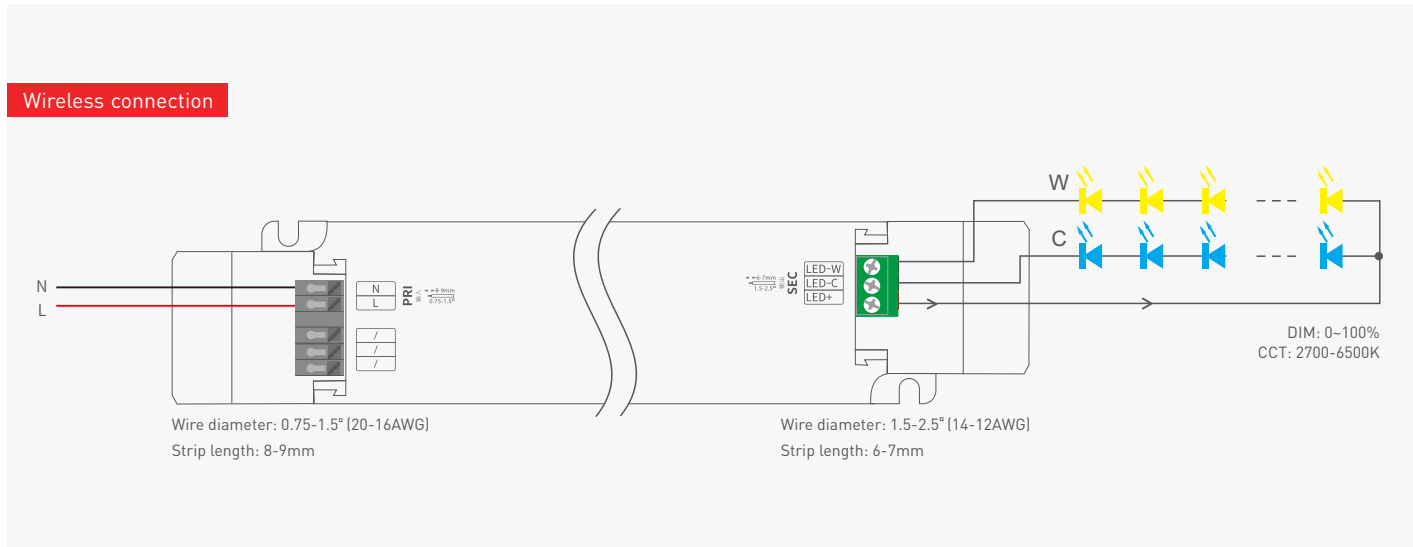

Protective Housing Application Diagram

Tension plate

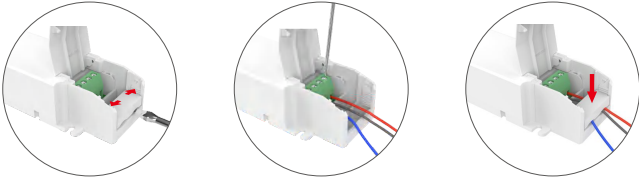

1. Pry up the protecting housing in the side plate position with a tool.
2. Connect to electrical wires with a screwdriver as wiring diagram shows.
3. Press down the tension plate to fix the the electrical wires, then close the protective housing.

Remove the protective housing

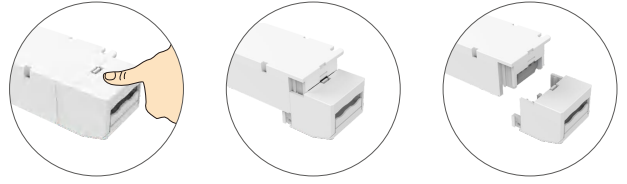

Pull the housing left and right from the bottom to remove it.

Installation Precautions

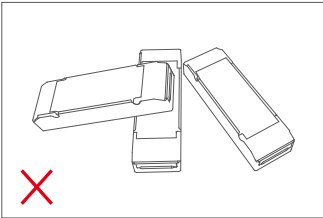

Please do not stack the products. The distance between two products should be $\geq 15\text{cm}$ so as not to affect heat dissipation and the lifespan of the products.

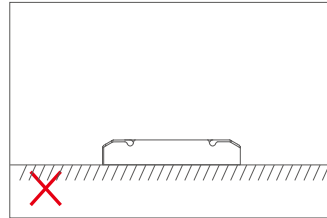
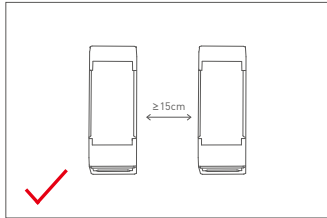

Please do not place the products on the floor. The distance between the product and the floor should be $\geq 100\text{cm}$ so as to avoid signal interference.

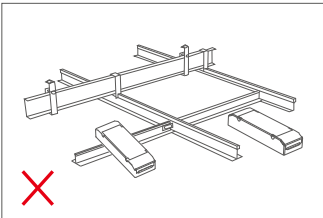
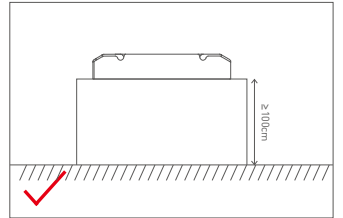

Please do not place the products near a large area of metal objects (such as metal stud ceilings). The distance between the product and the metal object should be $\geq 15\text{cm}$ so as to avoid signal interference.

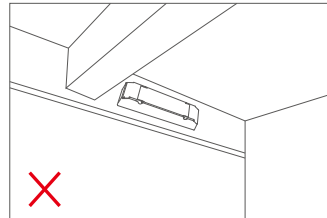
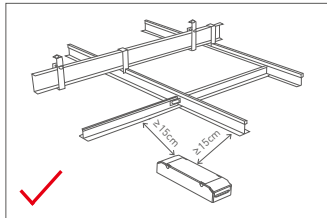

Please do not install the products on beams or near the corners. The distance between the product and the beam or the corner should be $\geq 15\text{cm}$ so as to avoid signal interference.

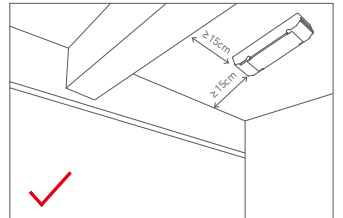

Relationship Diagrams

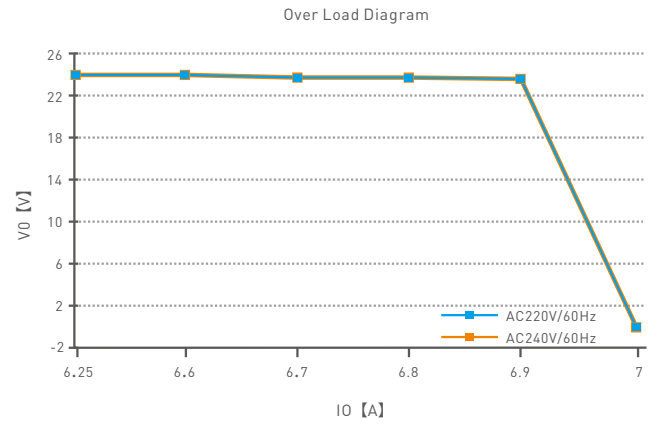
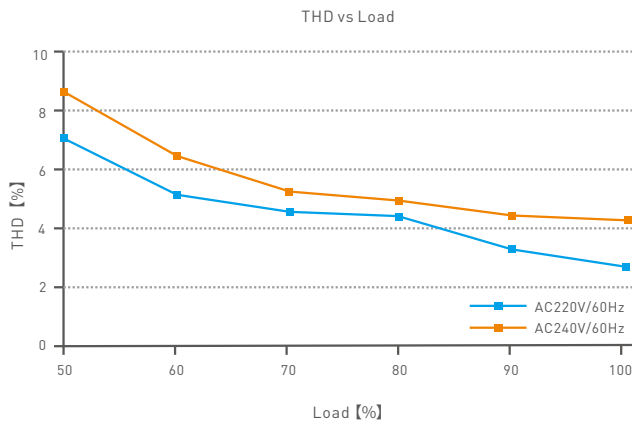
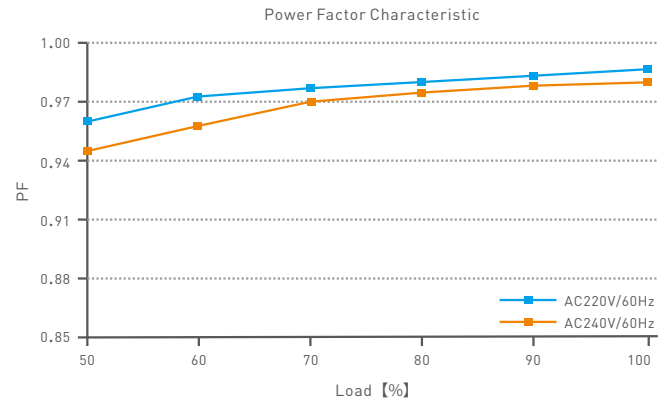
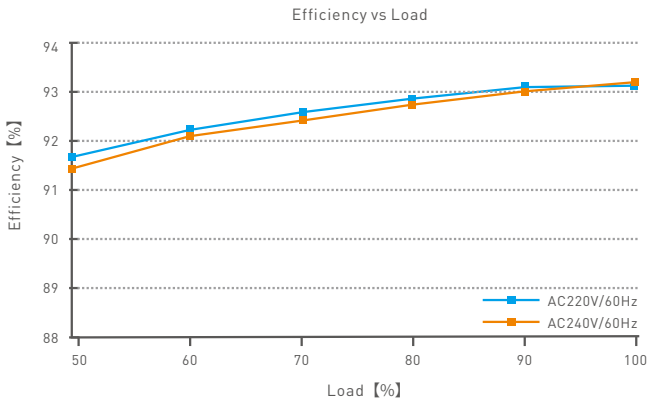

Flicker Test Table

Limit Value of Modulation in Low Risk Areas	
Waveform frequency of optical output (f)	Limit value (%)
$f \leq 8\text{Hz}$	0.2
$8\text{Hz} < f \leq 90\text{Hz}$	$0.025 \times f$
$90\text{Hz} < f \leq 1250\text{Hz}$	$0.08 \times f$
$f > 1250\text{Hz}$	Exemption assessment
Limit Value of Modulation in No Effect Areas	
Waveform frequency of optical output (f)	Limit value (%)
$f \leq 10\text{Hz}$	0.1
$10\text{Hz} < f \leq 90\text{Hz}$	$0.01 \times f$
$90\text{Hz} < f \leq 3125\text{Hz}$	$[0.08/2.5] \times f$
$f > 3125\text{Hz}$	Exemption assessment (High frequency exemption)

Brightness

- ▲ 0.1%
- ◆ 1%
- ◆ 5%
- ◆ 10%
- 20%
- ◆ 30%
- 40%
- ★ 50%
- 60%
- 70%
- ◆ 80%
- ★ 90%
- ◆ 100%

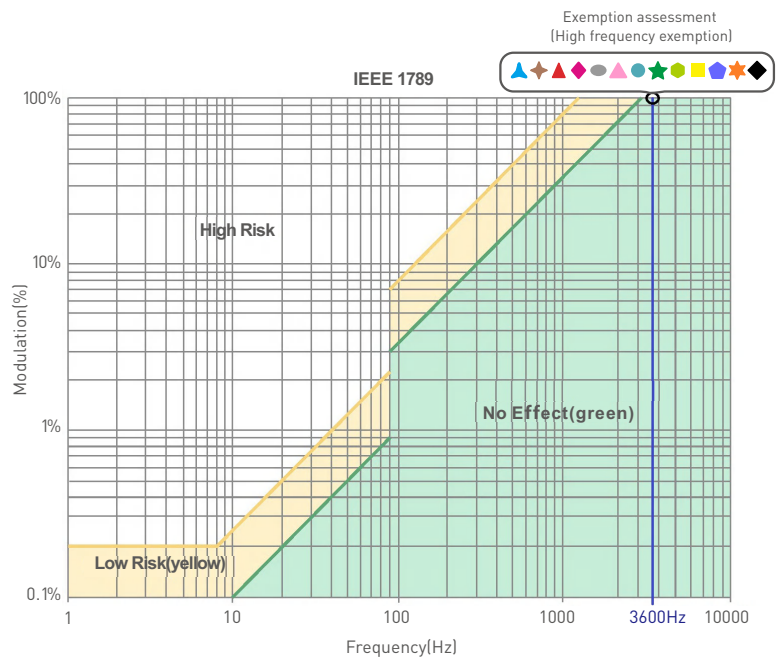

Marks in the right chart are tested results of different current levels
 The output frequency is 0Hz in 100% brightness and its corresponding modulation is 0%, which could not be shown in the right chart.

App Operating Instructions

1. Register an account

Tuya Smart App is compatible with iOS and Android systems. Scan the QR code below with you mobile phone and follow the prompts to complete the app installation. After installation being completed, you can log in or register an account.

APP support



App download

2. Paring instructions

A new user clicks "Me" → "Home Management" → "Create a Home", give a name to your home and confirm your home location, Then click "My Home" to add devices. After you enable appropriate permissions, click "+" icon → "Auto Scan" and the available Bluetooth/Wi-Fi/Zigbee/wired devices will be automatically found. Follow the prompts to add the device. [Please ensure that the device is ready for network connection].

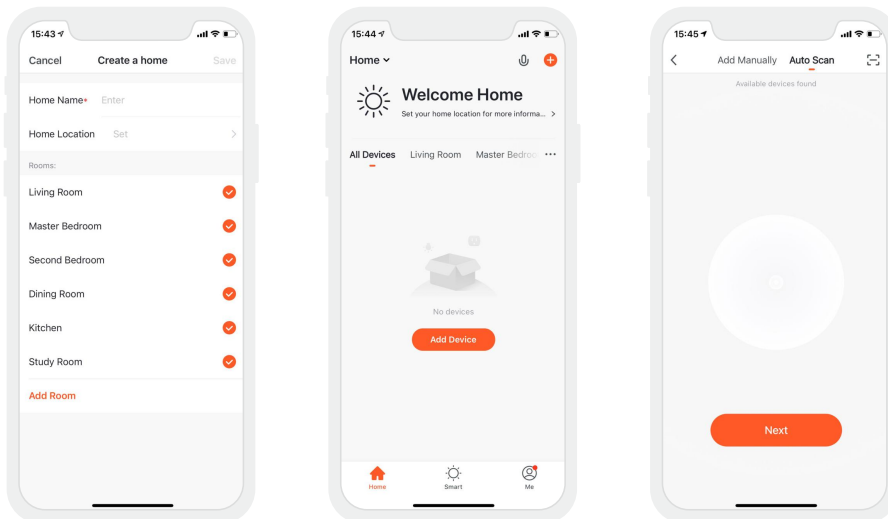

3. Lighting control settings

After paring up your device, click the device you add and adjust to your desired lighting status by changing brightness and color temperature. In "Settings", there are also lighting alarm clock and countdown functions (Tuya Zigbee Gateway needs to be added).

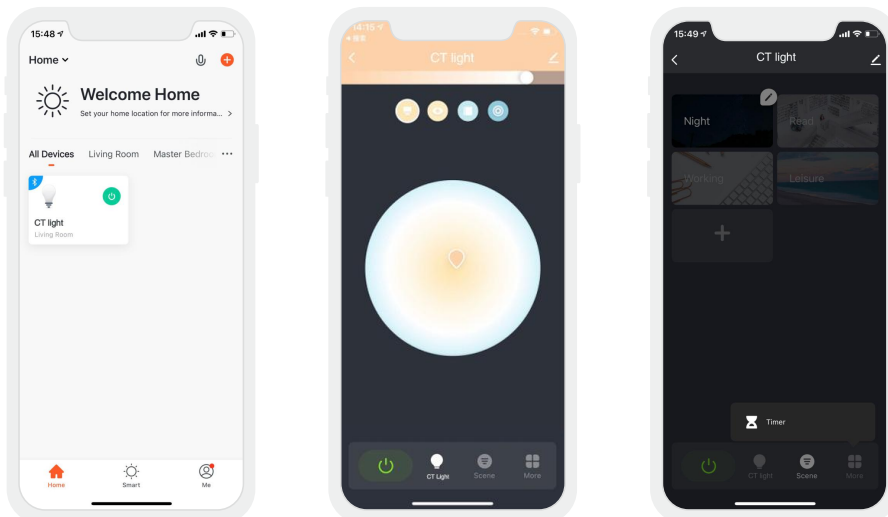

4. Remote control and automation

4.1 Remote control: Follow the prompts to add the Tuya Zigbee Gateway and go to the gateway interface after you added it. Click "Add Subdevice" and add the devices to the gateway, then you're able to remotely control the devices.

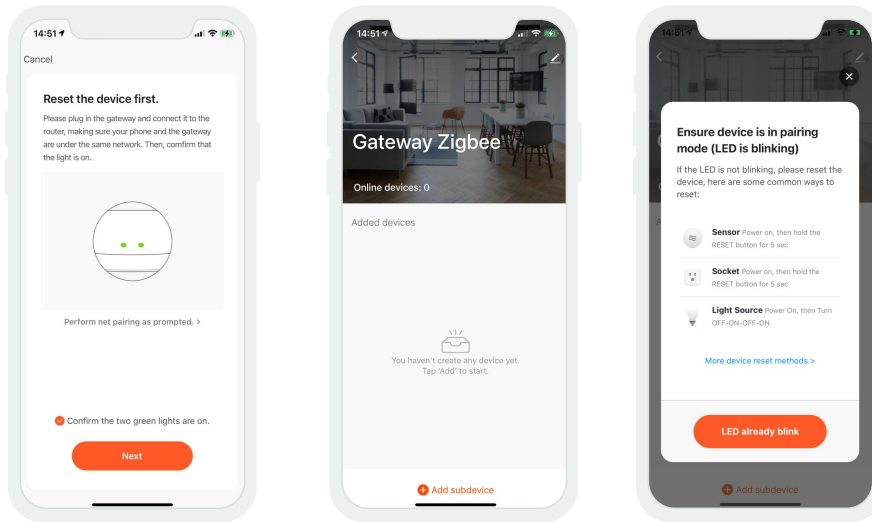

4.2 Automation settings: You can remotely control the light fixtures through "Automation" in "Smart" interface. Set trigger conditions like weather, location, timing and other device status to trigger the predefined lighting effects and achieve the lighting automation.

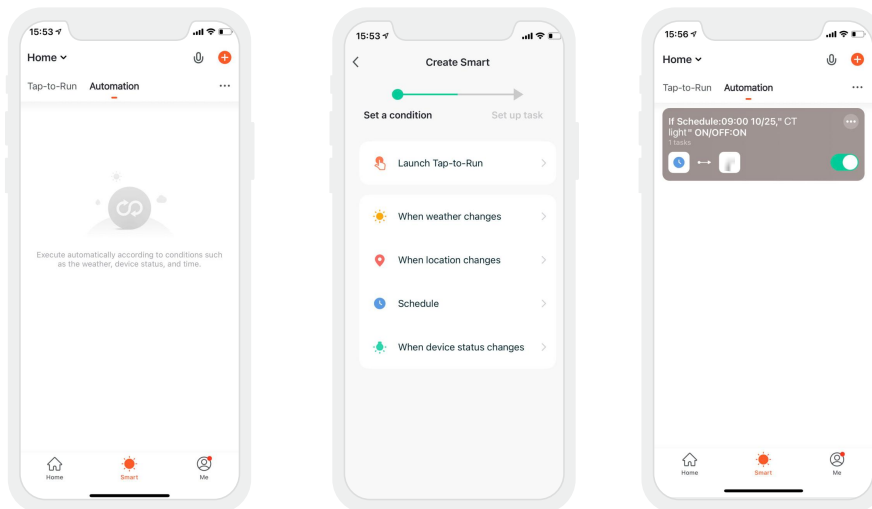

Reset The Device (Reset to factory defaults)

When the driver is power-on, turn it off and after 15s turn it on. After 2s, turn it off again. Repeat the same operation 5 times and then turn on the driver again. When the lamp is flashing (2 flashes/s), reset the device successfully.

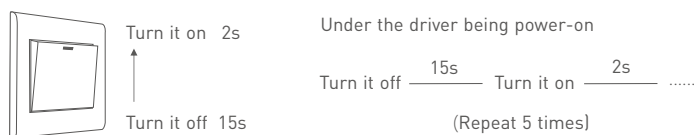

Packaging Specifications

Model	LM-150-24-G2Z2
Carton Dimensions	370x340x93mm(LxWxH)
Quantity	10 PCS/Layer; 2 Layers/Carton; 20 PCS/Carton
Weight	0.43 kg/PC; 9.4 kg/Carton

Packaging Image



Inner Packaging Box



Carton Packaging

Transportation and Storage

1. Transportation

Products can be shipped via vehicles, boats and planes.

During transportation, products should be protected from rain and sun. Please avoid severe shock and vibration during the loading and unloading process.

2. Storage

The storage conditions should comply with the Class I Environmental Standards. The products that have been stored for more than six months are recommended to be re-inspected and can be used only after they have been qualified.

Attentions

- This product must be installed and adjusted by a qualified professional.
 - This product is non-waterproof (special models excepted). Please avoid the sun and rain. When installed outdoors, please ensure it is mounted in a water proof enclosure.
 - Good heat dissipation will extend the life the product. Please install the product in a environment with good ventilation.
 - When you install this product, please avoid being near a large area of metal objects or stacking them to prevent signal interference.
 - Please keep the product away from a intense magnetic field, a high pressure area or a place where lightning is easy to occur.
 - Please check whether the working voltage used complies with the parameter requirements of the product.
 - Before you power on the product, please make sure all the wiring is correct in case of incorrect connection that may cause a short circuit and damage the components, or trigger a accident.
 - If a fault occurs, please do not attempt to fix the product by yourself. If you have any question, please contact the supplier.
- * This manual is subject to changes without further notice. Product functions depend on the goods. Please feel free to contact our official distributors if you have any question.

Warranty Agreement

- Warranty periods from the date of delivery: 5 years.
- Free repair or replacement services for quality problems are provided within warranty periods.

Warranty exclusions below:

- Beyond warranty periods.
- Any artificial damage caused by high voltage, overload, or improper operations.
- Products with severe physical damage.
- Damage caused by natural disasters and force majeure.
- Warranty labels and barcodes have been damaged.
- No any contract signed by LTECH.

1. Repair or replacement provided is the only remedy for customers. LTECH is not liable for any incidental or consequential damage unless it is within the law.
2. LTECH has the right to amend or adjust the terms of this warranty, and release in written form shall prevail.

Update Log

Version	Updated Time	Update Content	Updated by
A0	2023.01.14	Original version	Liu Weili